

Televic Table-Top Solutions

Confidea[®]

Wired conference system

Table of Contents

FAMILY CONCEPT

DELEGATE EQUIPMENT

Confidea L-DD / L-CD V1.0	11
Confidea L-2D2D V1.0	13
Confidea L-DV V1.0	15
Confidea L-CV V1.0	17
Confidea L-DI / L-CI V1.0	19
Confidea L-2D2I V1.0	21
Confidea L-DIV / L-CIV V1.0	23
MIC38SL V1.0	25

INTERPRETER EQUIPMENT

ID2500 V2	28
ID5500 V2.1	30

CENTRAL EQUIPMENT

Confidea CU V1.0	34
CPU5500 V2	36
SPL5525 V2	38

ACCESSORIES

TEL10 V2	41
TEL151 V2	42

Family Concept



Delegate Equipment



Confidea L-DD/L-CD

WIRED DISCUSSION UNIT

Art. 71.98.0101 / 71.98.0111



Confidea L-DD

Description

The Confidea L-DD and L-CD wired unit combines a slim, contemporary design with superior sound quality resulting in an excellent intelligibility.

The units are interconnected using the daisy chain principle over Cat 5 network cabling with RJ45 connectors. The connectors are hidden in the base of the unit and the cables are held in place by two notches in the unit housing.

Setup can be accomplished in just a blink of an eye.

As input and output connections are interchangeable, installation is easy, fast and straightforward, reducing installation cost. It is the ideal system for frequently changing environments.

Once installed delegates of a conference can speak, request-to-speak or listen to the currently active speaker.

The units are equipped with a microphone On/Off or request-to-speak button and headphone volume control buttons.

A screw lock connector is provided to connect a removable microphone.

As the microphone is immune against typical disturbances of mobile phones, delegates can leave their device on during the meeting. (MIC 38SL, to be ordered separately).



Confidea L-CD

Controls and Features

- Built-in high quality loudspeaker which is automatically muted when the microphone is active, to prevent acoustic feedback.
- Microphone On/Off or request-to-speak button with two signalling LEDs
- Two headphone outputs
- Headphone volume adjustments
- The chairman version (L-CD) comes with a priority, next-in-line and system volume adjustment button

Connectivity

- Two 3.5 mm jack plugs for headphones
- Two RJ45 connectors
- Screw lock socket to connect removable microphone

Specifications

Technical Data	
Audio quality	16 bit digital
Headphone load impedance	> 32 ohm < 1k ohm
Output power	16.5 mW / 32 ohm
Power Supply	48V, over Cat5 cable
Dimensions (mm)	230(w), 130(h), 60(d)
Weight (g)	480
Color	RAL9011
Part number	Confidea L-DD 71.98.0101 Confidea L-CD 71.98.0111

Accessories

- Removeable microphone
MIC38SL 71.98.0050
 - Headphones
TEL151 71.04.0151
 - Digital bus cable, Cat5 24AWG:
 - 2m ICC5/2 71.60.4002
 - 5m ICC5/5 71.60.4005
 - 10m ICC5/10 71.60.4010
 - 20m ICC5/20 71.60.4020
- Standard Ethernet patch cable AWG26 cannot be used!
- SPL5525 for connection to TCS5500 central equipment 71.67.5035

Confidea L-2D2D

WIRED DUAL DISCUSSION UNIT

Art. 71.98.0122

Description

The Confidea L-2D2D wired unit combines a slim, contemporary design with superior sound quality resulting in an excellent intelligibility.

The units are interconnected using the daisy chain principle over Cat 5 network cabling with RJ45 connectors. The connectors are hidden in the base of the unit and the cables are held in place by two notches in the unit housing.

Setup can be accomplished in just a blink of an eye.

As input and output connections are interchangeable, installation is easy, fast and straightforward, reducing installation cost. It is the ideal system for frequently changing environments.

Once installed, delegates of a conference can speak, request-to-speak or listen to the currently active speaker.

The units are equipped with two microphone On/Off or request-to-speak button and two separate headphone volume control buttons.

This dual use unit has two microphone buttons for individual microphone activation and individual delegate identification use for delegate management, speech time and camera tracking systems.

A screw lock connector is provided to connect a removable microphone.

As the microphone is immune against typical disturbances of mobile phones, delegates can leave their device on during the meeting. (MIC 38SL, to be ordered separately).



Confidea L-2D2D

Controls and Features

- Built-in high quality loudspeaker which is automatically muted when the microphone is active, to prevent acoustic feedback.
- Two Microphone On/Off or request-to-speak buttons with signalling LED
- Two headphone outputs
- Two Headphone volume adjustments

Connectivity

- Two 3.5 mm jack plugs for headphones
- Two RJ45 connectors
- Screw lock socket to connect removable microphone

Specifications

Technical Data	
Audio quality	16 bit digital
Headphone load impedance	> 32 ohm < 1k ohm
Output power	16.5 mW / 32 ohm
Power Supply	48V, over Cat5 cable
Dimensions (mm)	230(w), 130(h), 60(d)
Weight (g)	460
Color	RAL9011
Part number	Confidea L-2D2D 71.98.0122

Accessories

- Removeable microphone
MIC38SL 71.98.0050
 - Headphones
TEL151 71.04.0151
 - Digital bus cable, Cat5 24AWG:
 - 2m ICC5/2 71.60.4002
 - 5m ICC5/5 71.60.4005
 - 10m ICC5/10 71.60.4010
 - 20m ICC5/20 71.60.4020
- Standard Ethernet patch cable AWG26 cannot be used!
- SPL5525 for connection to TCS5500 central equipment 71.67.5035

Confidea L-DV

WIRED DELEGATE VOTING UNIT

Art. 71.98.0102

Description

The Confidea L-DV wired unit combines a slim, contemporary design with superior sound quality resulting in an excellent intelligibility.

The units are interconnected using the daisy chain principle over Cat 5 network cabling with RJ45 connectors. The connectors are hidden in the base of the unit and the cables are held in place by two notches in the unit housing.

Setup can be accomplished in just a blink of an eye.

As input and output connections are interchangeable, installation is easy, fast and straightforward, reducing installation cost. It is the ideal system for frequently changing environments.

Once installed, it allows the delegate of a conference to speak, request-to-speak, listen to the speaker and register their vote.

The units are equipped with a microphone On/Off or request-to-speak button, two headphone outputs with a single volume control.

Three voting buttons are used to take part in electronic voting sessions. Results of these sessions are distributed to the delegate units OLED voting result information display.

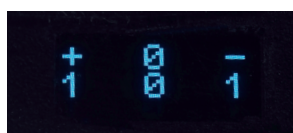

The voting session can be controlled via the chairmans voting unit control buttons.

For more advanced voting applications the dedicated Televic software suite can be used, allowing preparation of voting agenda,



Confidea L-DV

extended voting control, logging and result display.

A screw lock connector is provided to connect a removable microphone.

As the microphone is immune against typical disturbances of mobile phones, delegates can leave their device on during the meeting. (MIC 38SL, to be ordered separately)

Controls and Features

- Three voting buttons
- OLED voting result display
- Built-in high quality loudspeaker which is automatically muted when the microphone is active, to prevent acoustic feedback.
- Microphone On/Off or request-to-speak button with two signalling LEDs
- Two headphone outputs
- One headphone volume adjustment

Connectivity

- Two 3.5 mm jack plugs for headphones
- Two RJ45 connectors
- Screw lock socket to connect removable microphone

Specifications

Technical Data	
Audio quality	16 bit digital
Headphone load impedance	> 32 ohm < 1k ohm
Output power	16.5 mW / 32 ohm
Power Supply	48V, over Cat5 cable
Dimensions (mm)	230(w), 130(h), 60(d)
Weight (g)	460
Color	RAL9011
Part number	Confidea L-DV 71.98.0102

Accessories

- Removeable microphone
MIC38SL 71.98.0050
 - Headphones
TEL151 71.04.0151
 - Digital bus cable, Cat5 24AWG:
 - 2m ICC5/2 71.60.4002
 - 5m ICC5/5 71.60.4005
 - 10m ICC5/10 71.60.4010
 - 20m ICC5/20 71.60.4020
- Standard Ethernet patch cable AWG26 cannot be used!
- SPL5525 for connection to TCS5500 central equipment 71.67.5035

Confidea L-CV

WIRED CHAIRMAN VOTING UNIT

Art. 71.98.0112

Description

The Confidea L-CV wired unit combines a slim, contemporary design with superior sound quality resulting in an excellent intelligibility.

The units are interconnected using the daisy chain principle over Cat 5 network cabling with RJ45 connectors. The connectors are hidden in the base of the unit and the cables are held in place by two notches in the unit housing.

Setup can be accomplished in just a blink of an eye.

As input or output connections are interchangeable, installation is easy, fast and straightforward, reducing installation cost. It is the ideal system for frequently changing environments.

Once installed, it allows the chairman of a conference to speak, request-to-speak, listen to the speaker and register a vote. Apart from this the prior and next-in-line buttons allow to guide the meeting.

The units are equipped with a microphone On/Off or request-to-speak button, two headphone outputs with a single volume control.

Three voting buttons are used to take part in electronic voting sessions. Results of these sessions are distributed to all participant units OLED voting result information display.

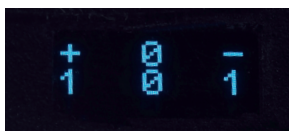

With the voting control buttons, voting sessions can be initiated, paused and ended.



For more advanced voting applications the dedicated Televic software suite can be used,



Confidea L-CV

allowing preparation of voting agenda, extended voting control, logging and result display.

A screw lock connector on the unit provides an easy way to connect a removable microphone.

As the microphone is immune against typical disturbances of mobile phones, delegates can leave their device on during the meeting. (MIC 38SL, to be ordered separately)

Controls and Features

- Three voting buttons
- Voting control buttons
- OLED voting result display
- Built-in high quality loudspeaker which is automatically muted when the microphone is active, to prevent acoustic feedback.
- Microphone On/Off or request-to-speak button with two signalling LEDs
- Two headphone outputs
- One headphone volume adjustment
- PRIOR and Next-in-line buttons

Connectivity

- Two 3.5 mm jack plugs for headphones
- Two RJ45 connectors
- Screw lock socket to connect removable microphone

Specifications

Technical Data	
Audio quality	16 bit digital
Headphone load impedance	> 32 ohm < 1k ohm
Output power	16.5 mW / 32 ohm
Power Supply	48V, over Cat5 cable
Dimensions (mm)	230(w), 130(h), 60(d)
Weight (g)	480
Color	RAL9011
Part number	Confidea L-CV 71.98.0112

Accessories

- Removeable microphone
MIC38SL 71.98.0050
 - Headphones
TEL151 71.04.0151
 - Digital bus cable, Cat5 24AWG:
 - 2m ICC5/2 71.60.4002
 - 5m ICC5/5 71.60.4005
 - 10m ICC5/10 71.60.4010
 - 20m ICC5/20 71.60.4020
- Standard Ethernet patch cable AWG26 cannot be used!
- SPL5525 for connection to TCS5500 central equipment 71.67.5035

Confidea L-DI/L-CI

WIRED DISCUSSION UNIT WITH CHANNEL SELECTOR

Art. 71.98.0103 / 71.98.0113



Confidea L-DI



Confidea L-CI

Description

The Confidea L-DI and L-CI wired unit combines a slim, contemporary design with superior sound quality resulting in an excellent intelligibility.

The units are interconnected using the daisy chain principle over Cat 5 network cabling with RJ45 connectors. The connectors are hidden in the base of the unit and the cables are held in place by two notches in the unit housing.

Setup can be accomplished in just a blink of an eye.

As input and output connections are interchangeable, installation is easy, fast and straightforward, reducing installation cost. It is the ideal system for frequently changing environments.

It allows the delegate of a conference to speak, request-to-speak and listen to the speaker in their native tongue.

The units are equipped with a microphone On/Off or request-to-speak button, a single channel selector driving two headphone outputs and a channel selection information display.

The OLED information display indicates the selected channel number, the abbreviated channel name in ISO format and a volume bar.

The chairman unit comes with an additional priority, next-in-line and system volume adjustment button.

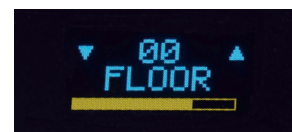

The Confidea L-DI and L-CI units have the capability selecting up to 28 (CE2500) or 58 (CPU5500) channels depending on the central control unit used.

A screw lock connector is provided to connect a removable microphone.

As the microphone is immune against typical disturbances of mobile phones, delegates can leave their device on during the meeting. (MIC 38SL, to be ordered separately)

Controls and Features

- Built-in high quality loudspeaker which is automatically muted when the microphone is active, to prevent acoustic feedback.
- Microphone On/Off or request-to-speak button with two signalling LEDs
- Two headphone outputs
- One headphone volume adjustment
- One channel Up/Down adjustment
- OLED channel and headphone volume information display
- The chairman version (L-CI) comes with a priority, next-in-line and system volume adjustment button

Connectivity

- Two 3.5 mm jack plugs for headphones
- Two RJ45 connectors
- Screw lock socket to connect removable microphone

Specifications

Technical Data	
Audio quality	16 bit digital
Headphone load impedance	> 32 ohm < 1k ohm
Output power	16.5 mW / 32 ohm
Power Supply	48V, over Cat5 cable
Dimensions (mm)	230(w), 130(h), 60(d)
Weight (g)	460
Color	RAL9011
Part number	Confidea L-DI 71.98.0103 Confidea L-CI 71.98.0113

Accessories

- Removeable microphone
MIC38SL 71.98.0050
 - Headphones
TEL151 71.04.0151
 - Digital bus cable, Cat5 24AWG:
 - 2m ICC5/2 71.60.4002
 - 5m ICC5/5 71.60.4005
 - 10m ICC5/10 71.60.4010
 - 20m ICC5/20 71.60.4020
- Standard Ethernet patch cable AWG26 cannot be used!
- SPL5525 for connection to TCS5500 central equipment 71.67.5035

Confidea L-2D2I

WIRED DUAL CHANNEL SELECTOR UNIT

Art. 71.98.0124

Description

The Confidea L-2D2I wired unit combines a slim, contemporary design with superior sound quality resulting in an excellent intelligibility.

The units are interconnected using the daisy chain principle over Cat 5 network cabling with RJ45 connectors. The connectors are hidden in the base of the unit and the cables are held in place by two notches in the unit housing.

Setup can be accomplished in just a blink of an eye.

As input and output connections are interchangeable, installation is easy, fast and straightforward, reducing installation cost. It is the ideal system for frequently changing environments.

Once installed, delegates of a conference can speak, request-to-speak or listen to the currently active speaker in their native tongue.

The units are equipped with two microphone On/Off or request-to-speak button and two individually controllable channel selectors including separate OLED displays indicating chosen channel number, abbreviated channel name and headphone volume.

This dual use unit has two microphone buttons for individual microphone activation and individual delegate identification used for delegate management, speech time and camera tracking systems.

The Confidea L-2D2I units have the capability selecting up to 28 (CE2500) or 58 (CPU5500) channels depending on the central control unit used.

A screw lock connector is provided to connect a removable microphone.

As the microphone is immune against typical disturbances of mobile phones, delegates can leave their device on during the meeting. (MIC 38SL, to be ordered separately).



Confidea L-2D2I

Controls and Features

- Built-in high quality loudspeaker which is automatically muted when the microphone is active, to prevent acoustic feedback.
- Two Microphone On/Off or request-to-speak buttons with signalling LED
- Two headphone outputs
- Two Headphone volume adjustments
- Two channel Up/Down adjustments
- Two channel and headphone volume information displays

Connectivity

- Two 3.5 mm jack plugs for headphones
- Two RJ45 connectors
- Screw lock socket to connect removable microphone

Specifications

Technical Data	
Audio quality	16 bit digital
Headphone load impedance	> 32 ohm < 1k ohm
Output power	16.5 mW / 32 ohm
Power Supply	48V, over Cat5 cable
Dimensions (mm)	230(w), 130(h), 60(d)
Weight (g)	480
Color	RAL9011
Part number	Confidea L-2D2I 71.98.0124

Accessories

- Removeable microphone
MIC38SL 71.98.0050
 - Headphones
TEL151 71.04.0151
 - Digital bus cable, Cat5 24AWG:
 - 2m ICC5/2 71.60.4002
 - 5m ICC5/5 71.60.4005
 - 10m ICC5/10 71.60.4010
 - 20m ICC5/20 71.60.4020
- Standard Ethernet patch cable AWG26 cannot be used!
- SPL5525 for connection to TCS5500 central equipment 71.67.5035

Confidea L-DIV/L-CIV

WIRED VOTING UNIT WITH CHANNEL SELECTOR

Art. 71.98.0104 / 71.98.0114



Confidea L-DIV



Confidea L-CIV

Description

The Confidea L-DIV and L-CIV wired unit combines a slim, contemporary design with superior sound quality resulting in an excellent intelligibility.

The units are interconnected using the daisy chain principle over Cat 5 network cabling with RJ45 connectors. The connectors are hidden in the base of the unit and the cables are held in place by two notches in the unit housing.

Setup can be accomplished in just a blink of an eye.

As input and output connections are interchangeable, installation is easy, fast and straightforward, reducing installation cost. It is the ideal system for frequently changing environments.

It allows the delegate of a conference to speak, request-to-speak, listen to the speaker in their native tongue and register their votes.

The units are equipped with a microphone On/Off or request-to-speak button, a single channel selector driving two headphone outputs, a channel selection information display and five voting buttons

The OLED information display indicates the selected channel number, the language abbreviation in ISO format and a volume bar.

The chairman unit comes with an additional priority, next-in-line and system volume adjustment button.

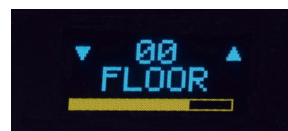

The Confidea L-DIV and L-CIV units have the capability selecting up to 28 (CE2500) or 58 (CPU5500) channels depending on the central control unit used.

For 5 button voting applications the dedicated Televic software suite can be used, allowing preparation of voting agenda, extended voting control, logging and result display.

A screw lock connector is provided to connect a removable microphone.

As the microphone is immune against typical disturbances of mobile phones, delegates can leave their device on during the meeting. (MIC 38SL, to be ordered separately)

Controls and Features

- Built-in high quality loudspeaker which is automatically muted when the microphone is active, to prevent acoustic feedback.
- Microphone On/Off or request-to-speak button with two signalling LEDs
- Two headphone outputs
- One headphone volume adjustment
- One channel Up/Down adjustment
- OLED channel and headphone volume information display
- Five voting buttons
- The chairman version (CIV) comes with a priority, next-in-line and system volume adjustment button

Connectivity

- Two 3.5 mm jack plugs for headphones
- Two RJ45 connectors
- Screw lock socket to connect removable microphone

Specifications

Technical Data	
Audio quality	16 bit digital
Headphone load impedance	> 32 ohm < 1k ohm
Output power	16.5 mW / 32 ohm
Power Supply	48V, over Cat5 cable
Dimensions (mm)	230(w), 130(h), 60(d)
Weight (g)	460
Color	RAL9011
Part number	Confidea L-DIV 71.98.0104 Confidea L-CIV 71.98.0114

Accessories

- Removeable microphone
MIC38SL 71.98.0050
 - Headphones
TEL151 71.04.0151
 - Digital bus cable, Cat5 24AWG:
 - 2m ICC5/2 71.60.4002
 - 5m ICC5/5 71.60.4005
 - 10m ICC5/10 71.60.4010
 - 20m ICC5/20 71.60.4020
- Standard Ethernet patch cable AWG26 cannot be used!
- SPL5525 for connection to TCS5500 central equipment 71.67.5035

MIC38SL

REMOVEABLE MICROPHONE

Art. 71.98.0050



Description

The removeable goosneck microphone is equipped with a screwlock connector for easy connection to the different Confidea units.

Its uni-directional response results in optimal performance even in noisy conditions.

Another important characteristic is the very low susceptibility to interference from mobile phones.

Specifications

Technical Data	
Pick-up pattern	Cardioid
Frequency response	50 Hz to 20 kHz
Sensitivity (1kHz) (free field, no load)	8 mV/Pa ± 2,5 dB
Nominal impedance	1kΩ
Min. Terminating impedance	5kΩ
Equivalent noise level	
A-weighted (DIN IEC 651)	26 dB
CCIR-weighted (CCIR 468-3)	36 dB
Max. SPL (1kHz)	133 dB
Connection	screwlock
Length	380 mm
Weight	±68g
Finish	Matt black, scratch resistant
Part Number	71.98.0050

Interpreter Equipment



Description

The ID2500 Digital Interpreter Desk features a unique and attractive design. It is supplied in an attractively designed elegant housing, and conforms to all relevant international norms.

The ID2500 features easy and intuitive operation and can accommodate the floor language plus 4, 8 or 28 languages. Up to 8 interpreter desks can be installed per booth. An integrated graphical LCD display with backlighting indicates information relevant to the interpreter.

Interpreters can easily select the incoming languages of their choice by using the 3 relay preset buttons with red indicator LED. These buttons are easily programmed by pressing and holding the relay preset button and cycling through the available language channels on the LCD display with the up and down controls. Releasing the relay-preset button programmes the selected language.

Interpreters get an indication on the graphical LCD display of the quality of the incoming languages. This way they can distinguish between a direct and an indirect interpretation, thereby avoiding indirect interpretations whenever possible.

Controls and Features

- Integrated electret condenser gooseneck microphone, with built-in illuminator ring.
- Integrated loudspeaker with rotary volume control and up and down channel selector. The loudspeaker is activated when no interpreter microphones in the booth are active.
- Headphones rotary volume, bass and treble controls.
- Up and down controls for selection of relay preset languages and Outgoing Channel B



- 3 relay-preset buttons for selection of incoming languages.
- Outgoing Channel A and Outgoing Channel B selection keys with red 'engaged' LED indicators.
- The interpreter can program the Outgoing Channel B individually.
- Graphical 122 x 32 dots LCDisplay with backlighting, used for indicating
 - Incoming languages
 - Interpretation quality (Floor +, -)
 - Outgoing channels
 - Status of loudspeaker
 - Set-up mode (not accessible in normal operation mode)
- Large Red Microphone On/Off button with red LED
- Grey Mute button
- Message button with acknowledge LED indicator for various types of calls.

Accessories

- Digital bus cable, RJ45 24AWG:
2m (ICC5/2 71.60.4002)
5m (ICC5/5 71.60.4005)
10m (ICC5/10 71.60.4010)
20m (ICC5/20 71.60.4020)
Standard Ethernet patch cable AWG26 cannot be used!
- Headphones TEL10 (71.04.1214)
- Headphones TEL151 (71.04.0151)
- Chip Card CC5500 (71.43.2000)

Connectivity

- Two RJ 45 connectors for separate loop through cabling of the TMS digital data bus (IN and OUT), max 20 units/bus
- Two 3.5 mm jack plug for headphones
- One 3.5 mm jack plug for headset connection (microphone and headphone combination)



Technical Data

Standards	IEC 268, IEC914, ISO4043
Frequency response	100-14000 Hz
Microphone pick-up pattern	cardioid
Length microphone	380 mm
Headphone output power	1.7 V at 90 mW
Headset input sensitivity	6.3 mV
Headset input impedance	$\geq 1k\Omega$ (at 1 kHz)
S/N at headphone output	> 68 dBA
Power Supply	48 VDC, supplied by CE2500
Power consumption	2.5 W
Operating temperature	+5 ... +50 °C
Dimensions	150(w), 80(h), 185(d) mm
Weight (g)	± 0.7 kg
Color	Charcoal Pantone Black 7C
Housing	Recyclable ABS
Part Number	71.60.2103 (Delegate) 71.60.2104 (Chairman)



Description

The ID5500 Interpreter Desk features a unique and attractive design. It is supplied in a professional all metal housing, and conforms to all relevant international norms. All interpreter desks are identical and interchangeable in case of malfunction. A malfunction in one interpreter desk has no influence on the operation of any other interpreter desk in the system.

The ID5500 offers easy and intuitive operation and can accommodate the floor language plus 58 languages. Up to 15 interpreter desks can be installed per booth. An integrated alphanumeric LCD display indicates information relevant to the interpreter.

Interpreters can easily select the incoming languages of their choice by using the 5 relay preset buttons with red indicator LED. These buttons are easily programmed by pressing and holding the relay preset button and cycling through the available language channels on the LCD display with the up and down controls. Releasing the relay preset button programs the selected language. The relay preset is activated by pressing the white relay button with green LED indicator.

Interpreters get an indication on the LCD display of the quality of the incoming languages. This way they can distinguish between a direct and an indirect interpretation, thereby avoiding indirect interpretations whenever possible.

Controls and Features

- Removable goose-neck microphone TGM407 with built-in illuminator ring
- Integrated loudspeaker with rotary volume control and up and down channel selector. The loudspeaker is activated when no interpreter desks in the booth are active
- Headphones rotary volume, bass and treble controls.
- Up and down controls for selection of relay preset languages and Outgoing Channel B
- 5 relay preset buttons for selection of incoming languages.
- Relay button for activation of relay interpretation. The relay button has "on/off" and "autofloor" LED indicators
- Yellow Outgoing Channel A and Outgoing Channel B selection keys with red 'engaged' LED indicators. Each interpreter can program the Outgoing Channel B individually

- 64 x 240 dots graphical LCD display with backlighting, used for indicating
 - incoming languages
 - interpretation quality (FL, -1, -2)
 - outgoing channels
 - messages
 - status of loudspeaker + headphones
 - Setup mode (not accessible in normal operation mode)
- Red Microphone On/Off button with two color (green & red) LED bar
- Black Mute button
- Grey Info button with green LED indicator, which lights up when a new message is available. Pressing the info button displays the message on the first two lines of the LCD screen
- Call button with acknowledge LED indicator for various types of calls and for intercom function
- Slow Down button to alert chairman that speakers are talking too fast This functionality requires extra hardware near the chairman (DCSL5500 + 71.67.0040)
- LED indicators to warn interpreter that there is an internal (intercom) or external (phone) call



Connectivity

- 5-pin XLR female connector for removable gooseneck microphone
- 2 RJ45 8-pin connectors (digital bus: IN and OUT)
- 3,5mm jack socket for headphones
- 3,5mm jack socket for external microphone

- Headset socket
- 7-pin DIN connector for headset
- 1 RJ45 8-pin connector for connection to peripheral devices:

Activation of EXT and INT LED on desk via telephone indicator board (71.69.5528)

Driving of 'On-Air' indicator light via driver board (71.69.5522)

Accessories

- Gooseneck microphone TGM407 (included)
- Headphones TEL10
- Lightweight headphones TEL151
- Digital bus cable YPC to interconnect ID5500 Interpreter Desks and to connect to the central unit

YPC1	1m	(71.67.4001)
YPC2	2m	(71.67.4002)
YPC5	3m	(71.67.4005)
YPC10	10m	(71.67.4010)
YPC20	20m	(71.67.4020)

Specifications

Technical Data	
Standards	IEC 914 ISO 2603-latest edition
Mounting	Desktop, flush mounting or semi-flush mounting
Dimensions (mm)	108(h)x 370(w) x 200(d) (without microphone) (h = 510mm with microphone)
Weight (g)	+/- 3.420
Colour	RAL7021 (Matt Black)
Housing	Metal
Part Number	71.64.5044

Central Equipment







Description

The Confidea central unit is the heart of the Confidea digital Conference/Simultaneous Interpretation system. It comes in an all-metal 19" housing for rack or tabletop mounting.

The integrated supply powers delegates and interpreter units on 6 available branches. The central unit controls a max of 120 delegates. (Confidea range, all-in-one integrated panels and ID2500 interpreter desks).

In its basic configuration the Central unit can handle interpreter desks (ID2500) up to 4 translated languages for multilingual debates. Adding additional licenses, the supported number of languages can be increased upto 28.

Two analog inputs allow connection of e.g. wireless microphones, or other classic analog signal sources.

An XLR output can connect to a separate analog system, such as an external power amplifier, or an analog recorder.

An additional 15-pin Dsub connector outputs 6 unbalanced channels to be used for e.g. IR modulator.

All settings for the system are made via the central units local configuration menu.

Connectivity

- 6 RJ45 sockets for 6 branches with up to 20 units
- 2 three-pin XLR F connectors for analog inputs
- 1 three-pin XLR M connector for analog output of floor language, transformer balanced
- 1 Dsub 15-pin, offering 6 unbalanced analog outputs (programmable)
- One 3.5mm jack for headphones (front panel mounted)
- 3 serial ports RS-232 for optional PC, media and camera control

Controls & Features

- Rear mounted mains On/Off switch
- 5 programming buttons + rotary wheel
- Graphical display: 122x32 dots
- Headphone monitoring output

Technical Data

Audio Input	
Aux IN 1,2	XLR-3F, transformer balanced
Input voltage range	max +3 dBu
Input impedance	> 6 k Ω at 1 kHz
Frequency response	100-14000 Hz
Audio Output	
Aux OUT1	XLR-3M, transformer balanced
Output level	max. +8 dBu
Output impedance	\leq 200 Ω
Signal to noise ratio	78 dBA
Frequency response	100-14000 Hz
THD+N	\leq 0.05 % (1.5 dBu)
Aux OUT 2-6	15-pole sub-D, unbalanced
Output level	max. +0 dBu
Output impedance	< 100 Ω at 1 kHz
Signal to noise ratio	max. 83 dBA
Frequency response	100-14000 Hz
THD+N	\leq 0.5 % (1.5 dBu)
Headphone	
Output power	max. 90 mW at 32 Ω
Signal to noise ratio	75 dBA
Frequency response	100-14000 Hz
THD+N	\leq 0.2 % (0 dBu)
Power	
Mains Voltage	110-230V AC 50-60 Hz
Current Consumption	max. 3.5 A (230VAC), max. 7 A (115VAC)
Fuse	3.15 A (230VAC); 7A (115VAC)
Output Voltage	48V (Port 1-6)
Environment usage and dimentions	
Operating temperature	+5 ... +50 $^{\circ}$ C
Fan Noise	48 dBA SPL (1m)
Dimensions (mm)	483 (19"), 132 (3U), 213 (d)
Weight (g)	\pm 6 kg
RoHS Compliant	✓



Description

The CPU 5500 Central Unit is the heart of the Televic TCS 5500 digital conference system. This sophisticated unit can operate in stand-alone mode or with a control PC connected. It allows complete control over all aspects of the conference system: microphone management, simultaneous interpretation, language distribution, voting and audience interaction...

The LAN network connectivity allows to easily integrate the conference system in a networked environment. Communication between the central unit, one or more control PC's, slave PC's and video display PC's can be easily established via LAN cabling and the most commonly used protocol in the world: TCP/IP.

In stand-alone mode, the CPU5500 can provide basic conference management functions, including basic voting. With one or two control PC's (one for the complete system or one for the microphone system and one for the simultaneous interpretation system), even the most advanced applications are possible with the powerful TCS 5500 software modules.

For large installs, a virtually unlimited number of extension units and power supply units can be added to accommodate a virtually unlimited number of participants in the system.

As standard, the CPU5500 comes with 6 analog outputs and 2 analog inputs to connect various analog equipment, such as an infra-red language distribution system, a PA system, a N-1 hybrid coupling, etc...

Front Panel Controls

To allow the user to configure the conference parameters an interface consisting of an LCD display, a jog wheel and selection buttons is integrated in the front of the unit. In addition, 8 status LEDs are provided that visualise some important status levels.



A monitoring loudspeaker is installed behind the front panel allowing the operator to listen to a selectable channel. A 3.5 mm stereo headphone connector allows the operator to bypass the loudspeaker.

Connectivity

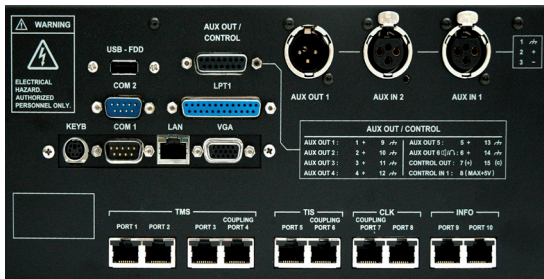

- Four RJ45 connectors for the TMS digital bus, allowing to connect 4 branches of digital interfaces directly to the unit.
- Two RJ45 connectors for the TIS digital bus
- LAN (Ethernet) connector for networking and control communication purposes
- Two RS 232 connectors for camera control, operator desk and bode unit connectivity
- Two RJ45 connectors for clock distribution to Extension Units
- One balanced audio output on XLR
- Two balanced audio inputs on XLR
- Six unbalanced analog outputs on D15
- For service applications
 - USB-FDD connector
 - (S)VGA connector
 - Keyboard connector
 - Parallel port connector

Options

- Digital audio INPUT and OUTPUT (AES/EBU) BNC and Fibre connector (71.61.0071)
- Opto-coupler board for room coupling applications (71.61.0081)

Specifications

Technical Data	
Dimensions (mm)	132.1(h) or 3U 483(w) or 19" 213(d)
Weight (g)	+/- 8.200
Colour	RAL7021 (Matt Black)
Housing	Metal
Part Number	71.64.5004



Description

The Digital Signal Splitter SPL5525 allows connection of 4 chains of mobile delegate units or integrated delegate flush mount panels to a TCS5500 system.

The splitter interfaces are connected to the central unit in daisy chain.

Replacement of a defective splitter interface can be effected without shutting down the system ("hot swapping").

The splitter needs to be powered separately with 48V, supplied by the CPU5500 or by a power supply PS5500

Connectivity

- Four 8-pin shielded RJ45 connectors each for a chain of max. 20 mobile delegate units or integrated delegate panels for flush mount
- Two 8-pin RJ45 connectors for the TMS digital data bus (IN and OUT)
- Two power supply connectors (IN and OUT)

Accessories

- Digital bus cable YPC to interconnect Digital Signal Splitters. This cable is also used to daisy-chain mobile delegate units or integrated delegate flush mount panels, and to connect to the central unit.

YPC1	1m	(71.67.4001)
YPC2	2m	(71.67.4002)
YPC5	3m	(71.67.4005)
YPC10	10m	(71.67.4010)
YPC20	20m	(71.67.4020)

- Fully assembled Power Supply Cable, ready for use:

PW2	2m	(71.67.4102)
-----	----	--------------

- Male power connector for mounting on custom cable.
One connector consists of a base part and a cover part.
(2 sets are included in the delivery):

Base part	(05.70.0153)
Cover part	(05.70.0155)

Specifications

Technical Data	
Dimensions (mm)	85 (h) x 173 (w) x 43.5(d)
Mounting	See drawings on reverse
Weight (g)	+/- 950
Colour	Stainless steel
Housing	Metal
Part Number	71.67.5035

Power Cable Layout

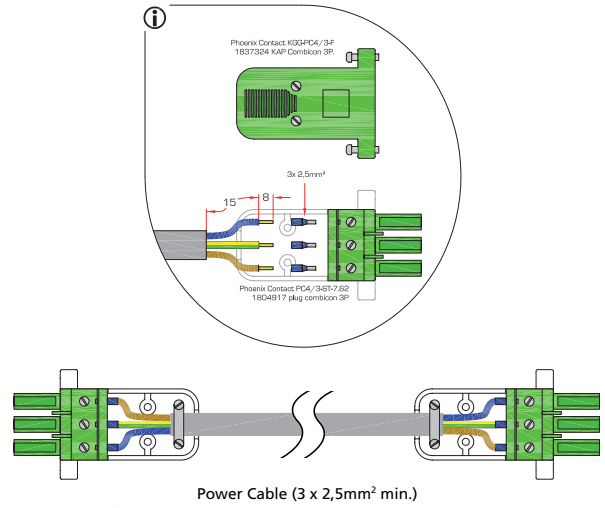

Dimensions

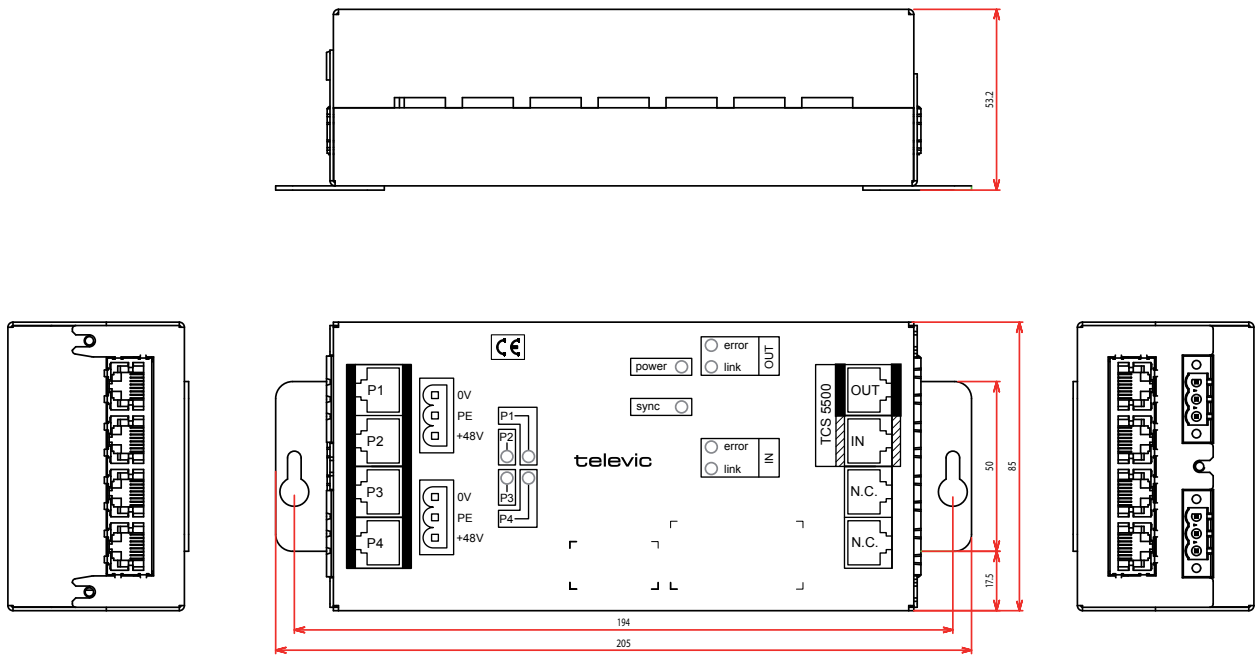

Accessories





Connectivity

- 1.5 m connection cable made of steel with 3.5 mm mono jack connector
- Angled 6.3 mm mono jack available upon request

Description

The TEL10 professional dynamic headphones were specifically developed for simultaneous interpretation applications

Controls and Features

- Excellent intelligibility and speech reproduction
- Adjustable steel wire headband.
- Hygienic, smooth ear cups for comfort and convenience
- Light pressure on ear, ensuring hours of comfortable wear
- Single cord, causing minimum disturbance to the user

Specifications

Technical Data	
Transducer principle	Dynamic
Frequency Response	100 Hz – 13 kHz
Impedance	360 Ohm
Sensitivity	98 dB/mW
Load rating	200 mW
THD	< 1 %
Contact Pressure	< 2.5 N
Weight (g)	+/- 90 g
Part Number	71.04.1214: 360 Ohm, avec jack 3,5 mm
	71.04.1215: 360 Ohm, avec jack 6,35 mm

TEL151

DELEGATE HEADPHONES

Art. 71.04.0151



Connectivity

- 1.5 m connection cable with 3.5 mm mono jack connector.

Accessories

- Pair of hard ear shells for optimal hygiene fitting the TEL151 (13.10.0151)

Description

The TEL151 lightweight dynamic delegate headphones were especially developed for modern conference applications.

Controls and Features

- Excellent intelligibility and speech reproduction
- Adjustable headband
- Rotating ear cups with replaceable foam ear pads for comfort and convenience
- Hard ear shells available as an option
- Light pressure on ear, ensuring hours of comfortable wear
- Single steel core cable, causing minimum disturbance to the user

Specifications

Technical Data	
Transducer principle	Dynamic
Frequency Response)	20 Hz – 20 kHz
Impedance	150 Ohm
Sensitivity	105 dB/mW (+ 3 dB at 1 kHz)
Nominal input	40 mW
Load rating	100 mW
THD	Less than 0.3 % (200 Hz – 2 kHz)
Contact Pressure	Lower than 2.5 N
Weight (g)	+/- 80 g
Part Number	71.04.0151